

HYUNDAI
POWER PRODUCTS

PETROL MULTI-TOOL

HCOMBIBP50

INSTRUCTIONS ORIGINALES

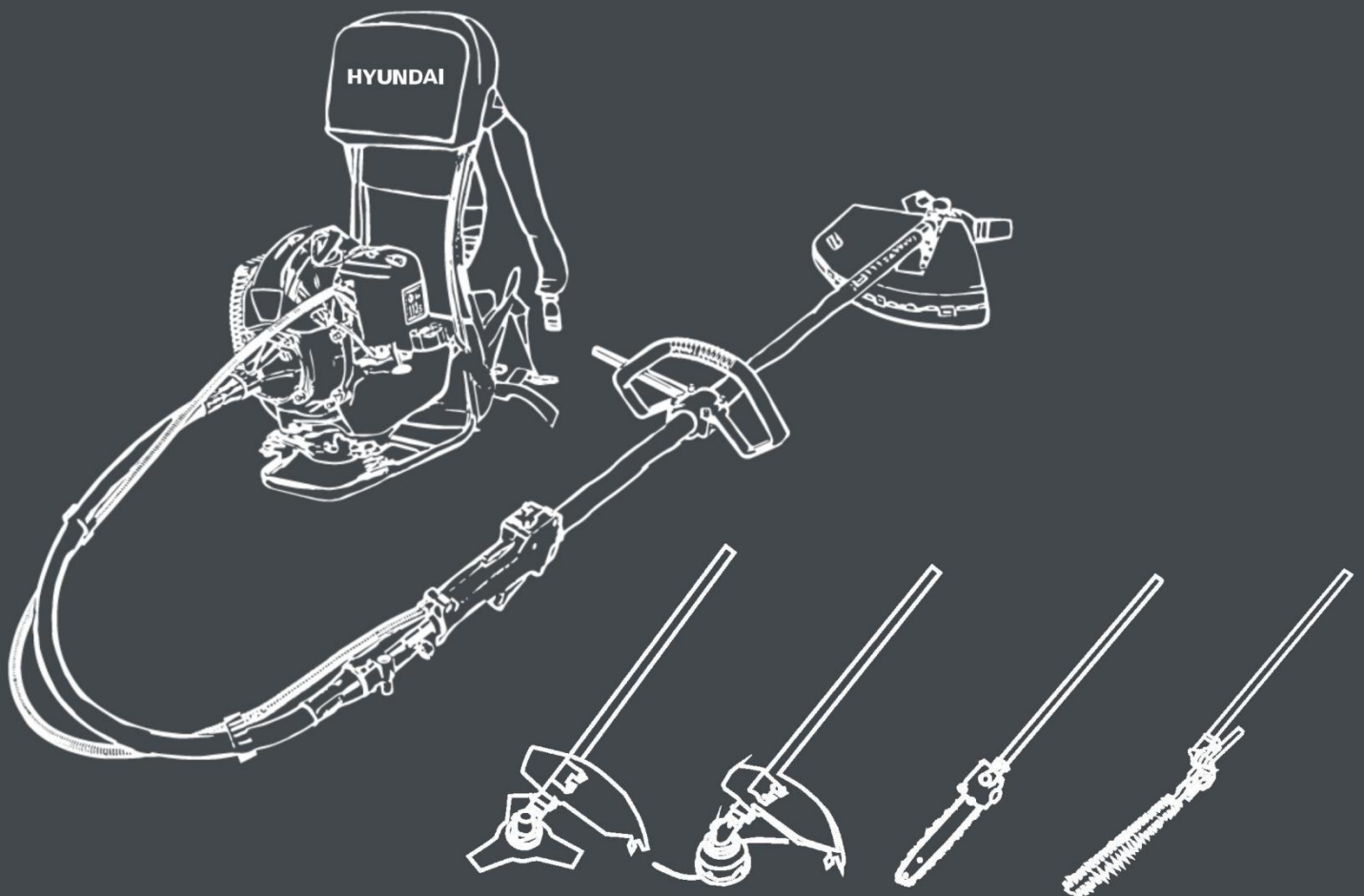

READ THE INSTRUCTIONS BEFORE USE THE TOOL !

1. SAFETY INSTRUCTIONS

Safety instructions for brushcutter and grass trimmer

Proper safety precautions must be observed. This unit must be handled carefully. **DO NOT EXPOSE YOURSELF OR OTHERS TO DANGER.**

Follow these general rules. Do not permit others to use this machine unless they are thoroughly responsible and have read, and understand the machine manual and are trained in its operation.

- Always wear safety goggles for eye protection. Dress properly; do not wear loose clothing or jewellery that could become caught in moving parts of the unit. Safe, sturdy, non-skid footwear should always be worn. Long hair should be tied back. It is recommended that legs and feet be covered to protect from flying debris during operation.
- Protective equipment must always be worn during the operation of the tool, including at least hearing protection, eye protection, helmet, gloves, and mask of protection, slip-resistant foot protection, and protective clothes.
- Inspect the entire machine for loose parts (nuts, bolts, screws, etc.) and any damage. Repair or replace as necessary before using the machine. **DO NOT USE** any attachment other than the ones recommended by our company. Serious injury to the operator or bystanders could result as well as damage to the machine. Ask advice to your dealer or manufacturer. Do not use cutting attachment such as metal multi-piece pivoting chains and flail blades.
- Secure the machine during transport to prevent loss of fuel, damage or injury; always install the protection device on the blade, check the cap of the fuel tank, and do not transport the tool upside down.
- Keep the handles free from oil and fuel.
- Always use proper handles and shoulder strap when cutting.
- Do not smoke while mixing fuel or filling tank.
- Do not mix fuel in an enclosed room or near open flames. Assure adequate ventilation.
- Always mix and store the fuel in a properly marked container that is approved by local codes and ordinances for such usage.
- Never remove the fuel tank cap while the engine is running.
- Never start or run the engine inside a closed room or building. Fumes from the exhaust contain dangerous carbon monoxide.
- Never attempt to make engine adjustments while the unit is running and strapped to the operator. Always make engine adjustments with the unit resting on a flat, clear surface.
- Do not use the unit if it is damaged or poorly adjusted. Never remove the machine's guard. Serious injury to the operator or bystanders could result as well as damage to the machine.
- Inspect the area to be cut and remove all debris that could become entangled in the nylon cutting head. Also remove any objects that the unit may throw during cutting.
- Keep children away. Onlookers should be kept at a safe distance from the work area, at least 15 meters.
- Never leave the machine unattended.
- Do not use this unit for any job other than those for which it is intended as described in this manual.
- Do not overreach. Keep proper footing and balance at all times. Do not run the unit while standing on a ladder or on any other unstable footing location.
- Keep hands and feet clear of the nylon cutting head or blade while unit is in use.

- Do not use this type of machine for sweeping away debris.
- Do not use the unit when you are tired, ill or under the influence of medication, drugs or alcohol.
- Use nylon cutting head which is free of damage. If a stone or any other obstacle is hit, stop the engine and check the nylon cutting head. A broken or unbalanced nylon cutting head must never be used.
- Do not store in a closed area where fuel vapors can reach an open flame from hot water heaters, furnaces, etc. Store in a locked, well-ventilated area only.
- Ensure safe and proper performance of your product. These parts are available from your dealer. The use of any other accessories or attachments may cause injuries to the user, damage to the machine and void this warranty.
- When refuelling, be sure to stop the engine and confirm that it is cooled down. Never refuel when the engine is running or hot. When gasoline spills, be sure to wipe it up completely dispose of those materials before starting the engine.
- Stay clear of other workers or bystanders by at least 15 meters.
- Whenever approaching an operator of the machine, carefully call his attention and confirm that the operator stop the engine. Be careful not to startle or distract the operator which can cause an unsafe situation.
- Never touch the nylon cutting head or blade whenever the engine is running. If it is necessary to replace the protector or cutting attachment, be sure to stop the engine and confirm that the cutting device has stopped running.
- The engine should be turned off when the machine is moved between work areas.
- Be careful not to hit the nylon cutting head against stones, or the ground.
- Unreasonable rough operation will shorten the life of the machine as well as create an unsafe environment for yourself and those around you.
- Pay attention to loosening and overheating of parts. If there is any abnormality of the machine, stop operation immediately and check the machine carefully. If necessary, have the machine serviced by an authorized dealer. Never continue to operate a machine which may be malfunctioning.
- In start-up or during operation of the engine, never touch hot parts such as the muffler, the high voltage wire or the spark plug.
- After the engine has stopped, the muffler is still hot. Never place the machine in any places where there are flammable materials (dry grass, etc.), combustible gasses or combustible liquids.
- Pay special attention to operation in the rain or just after the rain as the ground may be slippery.
- If you slip or fall to the ground or into a hole, release the throttle lever immediately.
- Be careful not to drop the machine or hit it against obstacles.
- Before proceeding to adjust or repair the machine, be sure to stop the engine and detach the spark plug.
- When the machine is placed in storage for a long time, drain fuel from the fuel tank and carburettor, clean the parts, move the machine to a safe place and confirm that the engine is cooled down.
- Make periodic inspections to assure safe and efficient operation. For a thorough inspection of your machine, please contact a dealer.
- Keep the machine away from fire or sparks.

- It is believed that a condition called Raynaud's phenomenon, which affects the fingers of certain individuals, may be brought about by exposure to vibration and cold. Loss of colour and numbness in the fingers. The following precautions are strongly recommended because the minimum exposure which might trigger the ailment is unknown.
- Keep your body warm, especially the head, neck, feet, ankles, hands and wrists.
- Maintain good blood circulation by performing vigorous arm exercises during frequent work breaks and also by not smoking.
- Limit the hours of operation. Try to fill each day with jobs where operating the brush cutter or other hand-held power equipment is not required.
- If you experience discomfort, redness and swelling of the fingers followed by whitening and loss of feeling, consult your physician before further exposing yourself to cold and vibration.
- Always wear ear protection, loud noise for long time can make hearing debase even lost hearing.
- Total face and head protection must be wearing to prevent damage from plummet or branch.
- Wear no-slip heavy duty work gloves to improve your grip on the brush cutter handle. Gloves also reduce the transmission of machine vibration to your hands.
- **WARNING:** The cutter area is still dangerous while the machine is coasting to a stop.
- When transport, this unit must be handled carefully. Do not expose yourself or others to danger.
- Envelop the blade before storage. Keep children away from it.
- Never remove the machine's guard.
- Clean and maintain the tool before storage (see the chapters on this manual). Bring maintenance after each use according the instructions of this manual. Improper maintenance can reduce the lie of the tool, bring bad results and wear the tool and its accessories.
- Check the tool before and after use. Check for loose fasteners, fuel leaks and damaged parts, such as cracks in the cutting attachment. If the tool is damaged, if parts are missed or meet some dysfunctions, do not use the tool and bring it to a service agent for inspection and reparation.
- Check the tool after dropping or other impacts to identify any significant defects; if any defects are observed, stop to use the tool and bring it to a service agent for inspection and reparation.
- Do not store in a closed area where fuel vapours can reach an open flame from hot water heaters, furnaces, etc. Store in a locked, well-ventilated area only.
- Never place the machine in any places where there are flammable materials (dry grass, etc.), combustible gasses or combustible liquids.
- When the machine is placed in storage for a long time, drain fuel from the fuel tank and carburettor, clean the parts, move the machine to a safe place and confirm that the engine is cooled down.
- Warning –Be careful about exhaust gases; do not inhale them and do not expose people to these gases.
- National regulation can restrict the use of the machine.
- Never modify a trimmer or cutter in any way.
- Improper use of the machine can cause **SERIOUS OR FATAL PERSONAL INJURY**.
- The engine exhaust form this product contains chemicals to cause cancer, birth defects, of other reproductive harm.
- Check regularly that the cutting attachment stops turning when the engine idles.

Kickback and Related Warnings

- Kickback is a sudden reaction to a pinched or snagged rotating wheel, backing pad, brush or any other accessory. Pinching or snagging causes rapid stalling of the rotating accessory which in turn causes the uncontrolled power tool to be forced in the direction opposite of the accessory's rotation at the point of the binding.
- For example, if an abrasive wheel is snagged or pinched by the workpiece, the edge of the wheel that is entering into the pinch point can dig into the surface of the material causing the wheel to climb out or kick out. The wheel may either jump toward or away from the operator, depending on direction of the wheel's movement at the point of pinching. Abrasive wheels may also break under these conditions.
- Kickback is the result of power tool misuse and/or incorrect operating procedures or conditions and can be avoided by taking proper precautions as given below:
 - o Never place your hand near the rotating accessory. Accessory may kickback over your hand.
 - o Do not position your body in the area where power tool will move if kickback occurs. Kickback will propel the tool in direction opposite to the wheel's movement at the point of snagging.
 - o Use special care when working corners, sharp edges etc. Avoid bouncing and snagging the accessory. Corners, sharp edges or bouncing have a tendency to snag the rotating accessory and cause loss of control or kickback.

Residual risks

Even if you use this tool correctly, there are always residual risks. The following hazards may arise in connection with the structure and manufacture of this power tool:

- Hearing impairment if no suitable hearing protection is worn.
- Cuts if no suitable protective clothing is worn.
- Health damage resulting from vibration in the hands and arms if the device is used for a long period of time or is not handled and maintained properly.
- Inhalation of particles
- Inhalation of exhaust gases
- Skin contact with oil / gasoline
- Inhalation of gasoline / oil vapors
- Contact with projected objects
- Burns when touching with hot surfaces
- Prolonged use of this product exposes the operator to vibration and can produce so-called "white finger" disease. To reduce the risk, wear gloves and keep your hands warm.
- If any of the symptoms of "white finger syndrome" occur, seek immediate medical attention. Symptoms of the "white finger" include numbness, loss of sensitivity, tingling, pain, loss of strength, colour changes or skin condition. These symptoms usually appear on the fingers, hands or wrists. Risk increases at low temperatures.
- Loss hearing in case of prolonged use and when a hearing protection is not worn.

To minimize those risks, follow the instructions of this manual about wearing personal equipment of protection, take some rest during the operation and the manipulation of the tool. Do not work for a prolonged time.

Safety instructions for the hedge trimmer

WARNING! Before using this tool, please read these instructions of safety and use. It will help you to use safely the machine and reduce the risk of electrical shocks and accidents. If you give this tool to another person, also give this manual.

Use this tool as described in this manual. Any mishandling and any use contrary to instructions will not in any way engage the liability of the manufacturer.

Non-compliance with safety instructions and use can cause a risk of electric shock, fire and / or injury to persons.

IMPORTANT
Read carefully before use
Keep for future reference

Safe operating practices

Training

Become familiar with the owner's manual before attempting to operate the equipment.

Preparation

- a) THIS HEDGE TRIMMER CAN CAUSE SERIOUS INJURIES. Read the instructions carefully for the correct handling, preparation, maintenance, starting and stopping of the hedge trimmer. Become familiar with all controls and the proper use of the hedge trimmer.
- b) Never allow children to use the hedge trimmer.
- c) Beware of overhead power lines.
- d) Avoid operating while people, especially children, are nearby.
- e) Dress properly! Do not wear loose clothing or jewellery, which can be caught in moving parts. Use of sturdy gloves, non-skid footwear and safety glasses is recommended.
- f) Use extra care when handling fuels. They are flammable and the vapours are explosive. The following points should be observed:
 - Use only an approved container.
 - Never remove the fuel cap or add fuel with the power source running. Allow engine and exhaust components to cool down before refuelling.
 - Do not smoke.
 - Never refuel indoors.
 - Never store the hedge trimmer or fuel container inside where there is an open flame, such as near a water heater.
 - If fuel is spilled, do not attempt to start the power source, but move the hedge trimmer away from the spillage before starting.
 - Always replace and securely tighten the fuel cap after refuelling.
 - If the fuel tank is drained, this should be done outdoors.
- g) If the cutting mechanism strikes any foreign object or the hedge trimmer starts making any unusual noise or vibration, shut off the power source and allow the hedge trimmer to stop. Disconnect the spark plug and take the following steps:
 - inspect for damage;
 - check for, and tighten, any loose parts;
 - have any damaged parts replaced or repaired with parts having equivalent specifications
- h) Wear ear protection.
- i) Wear eye protection.
- j) In case of emergency, stop the hedge trimmer; release the trigger, switch off the tool with the ON/OFF button. Let it completely stop and be cool before any intervention.

Operation

Use the tool for the intended purpose and follow these provided instructions for use and maintenance

- a) Stop the engine before:
 - cleaning or when clearing a blockage,
 - checking, carrying out maintenance or working on the hedge trimmer,
 - adjusting the working position of the cutting device,
 - Leaving the hedge trimmer unattended.

- b) Ensure that the hedge trimmer is correctly located in a designated working position before starting the engine.
- c) While operating the hedge trimmer, always ensure that the operating position is safe and secure, especially when using steps or a ladder.
- d) Do not operate the hedge trimmer with a damaged or excessively worn cutting device.
- e) To reduce fire hazards, keep the engine and silencer free of debris, leaves and excessive lubricant.
- f) Always ensure that all handles and guards are fitted when using the hedge trimmer. Never attempt to use an incomplete hedge trimmer or one fitted with an unauthorized modification.
- g) Always use two hands to operate a hedge trimmer fitted with two handles.

Maintenance and storage

- a) When the hedge trimmer is stopped for servicing, inspection or storage, shut off the power source, disconnect the spark plug wire from the spark plug and make sure all moving parts have come to a stop. Allow the hedge trimmer to cool before making any inspections, adjustments, etc.
- b) Store the hedge trimmer where the fuel vapour will not reach an open flame or spark. Always allow the hedge trimmer to cool down before storing.
- c) When transporting or storing the hedge trimmer, always fit the cutting device transport guard.

Additional instructions

- Warning - Never allow children to use the hedge trimmer.
- Work only during in the day or with a sufficient artificial light.
- Before starting to work, check the condition of the tool.
- Ensure that all the parts of the machine are well fixed and tightened.
- Control regularly that the blade of cut is in good state.
- Always hold firmly the hedge trimmer with the two hands.
- Never take or hold the hedge trimmer by the blade.
- Maintain clothing out of reach blade as well with the stop as under operation.
- Keep the device distant from all shapes of sparks, flames and flammable materials.
- Control that the working areas are free from all shapes of obstacles.
- Work with precaution, be not distracted.
- Do not use the tool when you are under the influence of alcohol, meds or drugs, and where you are sick.
- Dry all possible gasoline traces by using a dry rag.
- In case of accident, immediately stop using the machine. Check the problem. Do not use the machine while the machine is damaged.
- Operate the machine only at reasonable hours – not early in the morning or late at night when people might be disturbed;
- When blockage occurs, immediately turn off the engine with the ON/OFF button. Let the tool cool down. Check and correct the blockage before starting again to work. Use gloves when clearing a blockage. Restart the machine securely when the machine is totally unblocked.
- When a danger or a non-intended situation arise, stop to work immediately and switch off the tool. Restart to work when there is no danger and you are able to work safely.
- Cut before the large branches with a hand shears to avoid the blocking of the blade.
- Pay attention not to cut iron wire or others.
- Do not use non-recommended accessories with this tool. To replace any piece of this tool, please contact the retailer, service agent or manufacturer.
- Use only the mixture recommended by the manufacturer.
- Store the mixture in a specific container for the gasoline.
- Keep the device in a quite dry place and out of reach of children.
- Store the mixture only on free air or in a well-ventilated place. Handle the fuel with precaution, it is highly flammable.
- Do not smoke or use telephone when you handle gasoline.

- Use a funnel and fill the tank only when the engine is cold.
- Do not open the tank if the engine is hot or under operation.
- Keep people and yourself far away from the exhaust to avoid the risks of burns.
- Maintain the people and the animals far away from the working area.
- Always remind that this machine can cause very serious incidents.
- Do not work under the rain and/or in places wet and/or slipping.
- Do not expose to the rain.
- Do not use the tool during bad weather conditions and where a risk of lightning is possible.
- Use complete personal protective equipment during the use of the tool: gloves, antiskid footwear, helmet, eyes protection, protection clothes, and mask of protection.
- Do not use the machine when you are tired, under the influence of alcohol or drugs or sick.
- The machinery must not be used in a way where experience has shown that danger and/or risks might occur.
- Never use hedge trimmer inside a building. Your hedge trimmer produces toxic exhaust fumes as soon as the engine is started. The use of this product can generate dust, vapours and smoke containing chemicals known for their harmful effects on health. So be careful during the use of your machine and protect yourself correctly. Also avoid voluntarily breathing exhaust fumes; always hold the machine correctly when you use it.
- Regularly lubricate the blades of the trimmer by using a lubricant which is sold in specialized stores.

Residual risks

Even if you use this product in compliance with all safety requirements, the potential risks of injury and damage remain. The following hazards may arise in the structure and design of this product. Always be vigilant when using this product, so you can recognize and manage the risks rather. Rapid intervention can prevent serious injury and property damage.

- There are harmful health consequences resulting from the emission of vibrations if the product is used for long periods of time or not properly managed and properly maintained.
- There is risk of injury and property damage due to attachments or broken the sudden impact of hidden objects.
- Risk of injury to persons and property caused by flying objects.
- Prolonged use of this product exposes the operator to vibration and can produce so-called "white finger" disease. To reduce the risk, wear gloves and keep your hands warm. If any of the symptoms of "white finger syndrome" occur, seek immediate medical attention. Symptoms of the "white finger" include numbness, loss of sensitivity, tingling, tingling, and pain, loss of strength, colour changes or skin condition. These symptoms usually appear on the fingers, hands or wrists. Risk increases at low temperatures
- Inhalation of particles
- Inhalation of exhaust gases
- Unattended projections
- Contact with foreign objects
- Contact with the tool in operation
- Hearing loss in the absence of correct hearing protection

To minimize those risks, follow the instructions of this manual about wearing personal equipment of protection and the manipulation of the tool. Take some rest during the operation. Do not work for a prolonged time.

Safety warnings for the mounted pole pruner

Proper safety precautions must be observed. This unit must be handled carefully. **DO NOT EXPOSE YOURSELF OR OTHERS TO DANGER.**

Follow these general rules. Do not permit others to use this machine unless they are thoroughly responsible and have read, and understand the machine manual and are trained in its operation.

- Always wear safety goggles for eye protection. Dress properly; do not wear loose clothing or jewellery that could become caught in moving parts of the unit. Safe, sturdy, non-skid footwear should always be worn. Long hair should be tied back. It is recommended that legs and feet be covered to protect from flying debris during operation.
- Protective equipment must always be wear during the operation of the tool, including at least hearing protection, eyes protection, helmet, gloves, and mask of protection, slip-resistant foot protection, and protective clothes.
- Inspect the entire machine for loose parts (nuts, bolts, screws, etc.) and any damage. Repair or replace as necessary before using the machine. DO NOT USE any attachment other than the ones recommended by our company. Serious injury to the operator or bystanders could result as well as damage to the machine. Ask advice to you dealer of manufacturer. Do not use cutting attachment such as metal multi-piece pivoting chains and flail blades.
- Secure the machine during transport to prevent loss of fuel, damage or injury; always install the protection device on the blade, check the cap of the fuel tank, and do not transport the tool upside down.
- Keep the handles free from oil and fuel.
- Always use proper handles and shoulder strap when cutting.
- Do not smoke while mixing fuel or filling tank.
- Do not mix fuel in an enclosed room or near open flames. Assure adequate ventilation.
- Always mix and store the fuel in a properly marked container that is approved by local codes and ordinances for such usage.
- Never remove the fuel tank cap while the engine is running.
- Never start or run the engage inside a closed room or building. Fumes from the exhaust contain dangerous carbon monoxide.
- Never attempt to make engine adjustments while the unit is running and strapped to the operator. Always make engine adjustments with the unit resting on a flat, clear surface.
- Do not use the unit if it is damaged or poorly adjusted. Never remove the machine's guard. Serious injury to the operator or bystanders could result as well as damage to the machine.
- Inspect the area to be cut and remove all debris that could become entangled in the nylon cutting head. Also remove any objects that the unit may throw during cutting.
- Keep children away. Onlookers should be kept at a safe distance from the work area, at least 15 meters.
- Never leave the machine unattended.
- Do not use this unit for any job other than those for which it is intended as described in this manual.
- Do not overreach. Keep proper footing and balance at all times. Do not run the unit while standing on a ladder or on any other unstable footing location.
- Keep hands and feet clear of the nylon cutting head or blade while unit is in use.
- Do not use this type of machine for sweeping away debris.
- Do not use the unit when you are tired, ill or under the influence of medication, drugs or alcohol.
- Do not store in a closed area where fuel vapors can reach an open flame from hot water heaters, furnaces, etc. Store in a locked, well-ventilated area only.
- Ensure safe and proper performance of your product. These parts are available from your dealer. The use of any other accessories or attachments may cause a potential hazard or

injury to the user, damage to the machine and void this warranty.

- When refuelling, be sure to stop the engine and confirm that it is cooled down. Never refuel when the engine is running or hot. When gasoline spills, be sure to wipe it up completely dispose of those materials before starting the engine.
- Stay clear of other workers or bystanders by at least 15 meters.
- Whenever approaching an operator of the machine, carefully call his attention and confirm that the operator stop the engine. Be careful not to startle or distract the operator which can cause an unsafe situation.
- Never touch the nylon cutting head or blade whenever the engine is running. If it is necessary to replace the protector or cutting attachment, be sure to stop the engine and confirm that the cutting device has stopped running.
- The engine should be turned off when the machine is moved between work areas.
- Be careful not to hit the nylon cutting head against stones, or the ground.
- Unreasonable rough operation will shorten the life of the machine as well as create an unsafe environment for yourself and those around you.
- Pay attention to loosening and overheating of parts. If there is any abnormality of the machine, stop operation immediately and check the machine carefully. If necessary, have the machine serviced by an authorized dealer. Never continue to operate a machine which may be malfunctioning.
- In start-up or during operation of the engine, never touch hot parts such as the muffler, the high voltage wire or the spark plug.
- After the engine has stopped, the muffler is still hot. Never place the machine in any places where there are flammable materials (dry grass, etc.), combustible gasses or combustible liquids.
- Pay special attention to operation in the rain or just after the rain as the ground may be slippery.
- If you slip or fall to the ground or into a hole, release the throttle lever immediately.
- Be careful not to drop the machine or hit it against obstacles.
- Before proceeding to adjust or repair the machine, be sure to stop the engine and detach the spark plug.
- When the machine is placed in storage for a long time, drain fuel from the fuel tank and carburettor, clean the parts, move the machine to a safe place and confirm that the engine is cooled down.
- Make periodic inspections to assure safe and efficient operation. For a thorough inspection of your machine, please contact a dealer.
- Keep the machine away from fire or sparks.
- It is believed that a condition called Raynaud's phenomenon, which affects the fingers of certain individuals, may be brought about by exposure to vibration and cold. Loss of colour and numbness in the fingers. The following precautions are strongly recommended because the minimum exposure which might trigger the ailment is unknown.
- Keep your body warm, especially the head, neck, feet, ankles, hands and wrists.
- Maintain good blood circulation by performing vigorous arm exercises during frequent work breaks and also by not smoking.
- Limit the hours of operation. Try to fill each day with jobs where operating the brush cutter or other hand-held power equipment is not required.
- If you experience discomfort, redness and swelling of the fingers followed by whitening and

loss of feeling, consult your physician before further exposing yourself to cold and vibration.

- Always wear ear protection, loud noise for long time can make hearing debased even lost hearing.
- Total face and head protection must be wearing to prevent damage from plummet or branch.
- Wear no-slip heavy duty work gloves to improve your grip on the brush cutter handle. Gloves also reduce the transmission of machine vibration to your hands.
- **WARNING:** The cutter area is still dangerous while the machine is coasting to a stop.
- When transport, this unit must be handled carefully. Do not expose yourself or others to danger.
- Envelop the blade before storage. Keep children away from it.
- Never remove the machine's guard.
- Clean and maintain the tool before storage (see the chapters on this manual). Bring maintenance after each use according to the instructions of this manual. Improper maintenance can reduce the life of the tool, bring bad results and wear the tool and its accessories.
- Check the tool before and after use. Check for loose fasteners, fuel leaks and damaged parts, such as cracks in the cutting attachment. If the tool is damaged, if parts are missed or meet some dysfunctions, do not use the tool and bring it to a service agent for inspection and reparation.
- Check the tool after dropping or other impacts to identify any significant defects; if any defects are observed, stop to use the tool and bring it to a service agent for inspection and reparation.
- Do not store in a closed area where fuel vapours can reach an open flame from hot water heaters, furnaces, etc. Store in a locked, well-ventilated area only.
- Never place the machine in any places where there are flammable materials (dry grass, etc.), combustible gasses or combustible liquids.
- When the machine is placed in storage for a long time, drain fuel from the fuel tank and carburettor, clean the parts, move the machine to a safe place and confirm that the engine is cooled down.
- **Warning** –Be careful about exhaust gases; do not inhale them and do not expose people to these gases.
- National regulation can restrict the use of the machine.
- Never modify the tool in any way.
- Improper use of the machine can cause **SERIOUS OR FATAL PERSONAL INJURY**.
- The engine exhaust from this product contains chemicals to cause cancer, birth defects, or other reproductive harm.
- Check regularly that the cutting attachment stops turning when the engine idles.

Kickback and Related Warnings

- Kickback is a sudden reaction to a pinched or snagged rotating wheel, backing pad, brush or any other accessory. Pinching or snagging causes rapid stalling of the rotating accessory which in turn causes the uncontrolled power tool to be forced in the direction opposite of the accessory's rotation at the point of the binding.
- For example, if an abrasive wheel is snagged or pinched by the workpiece, the edge of the wheel that is entering into the pinch point can dig into the surface of the material causing the wheel to climb out or kick out. The wheel may either jump toward or away from the operator, depending on direction of the wheel's movement at the point of pinching. Abrasive wheels may also break under these conditions.
- Kickback is the result of power tool misuse and/or incorrect operating procedures or conditions and can be avoided by taking proper precautions as given below:

- Never place your hand near the rotating accessory. Accessory may kickback over your hand.
- Do not position your body in the area where power tool will move if kickback occurs. Kickback will propel the tool in direction opposite to the wheel's movement at the point of snagging.
- Use special care when working corners, sharp edges etc. Avoid bouncing and snagging the accessory. Corners, sharp edges or bouncing have a tendency to snag the rotating accessory and cause loss of control or kickback.

Residual risks

Even if you use this product in compliance with all safety requirements, the potential risks of injury and damage remain. The following hazards may arise in the structure and design of this product. Always be vigilant when using this product, so you can recognize and manage the risks rather. Rapid intervention can prevent serious injury and property damage.

- There are harmful health consequences resulting from the emission of vibrations if the product is used for long periods of time or not properly managed and properly maintained.
- There is risk of injury and property damage due to attachments or broken the sudden impact of hidden objects.
- Risk of injury to persons and property caused by flying objects.
- Prolonged use of this product exposes the operator to vibration and can produce so-called "white finger" disease. To reduce the risk, wear gloves and keep your hands warm. If any of the symptoms of "white finger syndrome" occur, seek immediate medical attention. Symptoms of the "white finger" include numbness, loss of sensitivity, tingling, tingling, and pain, loss of strength, colour changes or skin condition. These symptoms usually appear on the fingers, hands or wrists. Risk increases at low temperatures
- Inhalation of particles
- Inhalation of exhaust gases
- Unattended projections
- Contact with foreign objects
- Contact with the tool in operation
- Hearing loss in the absence of correct hearing protection

To minimize those risks, follow the instructions of this manual about wearing personal equipment of protection, take some rest during the operation and the manipulation of the tool. Do not work for a prolonged time.

Intended use

1) Brushcutter and grass trimmer

Intended use

This machine can be used as a trimmer with the cutting edge, and as a brushcutter with the cutting blade.

The grass trimmer must be strictly and only to cut grass or weeds that are not too dense. The brush cutter must be used to cut hard grass, more dense weeds and small branches with a maximum diameter of 10mm.

Improper use

This machine is not intended to cut bushes or others similar plants requiring the tool to get off the ground. Do not use this tool to work other materials such as stones, clay soils, etc.

2) **Mounted pole pruner**
Intended use / improper use

The pole pruner is exclusively intended for pruning trees and/or cutting small wood from the ground. Any other use is considered improper and will damage the tool.

The correct use also includes reading and observing the instructions for use at each use as well as observing the warnings fixed on the machine. Before and during use, it is imperative to check the blade to ensure that there is no mechanical damage. In case of necessary repairs, please contact your specialist dealer.

Only the use of spare parts approved by the manufacturer or original spare parts is permitted. If unauthorized or non-original spare parts are used, the user is liable for consequential injury to persons or property resulting in the manufacturer being deprived of all liability.

3) **Hedge trimmer**
Intended Use

Your hedge trimmer is a device used by a person to trim hedges and shrubs by working with one or more blades arranged linearly and back and forth. A potential hazard exists if the device is used for other purposes. Improper handling of the hedge trimmer increases the risk of injury from blades. Only the use of spare parts and accessories approved by the manufacturer is permitted.

Symbols



Read instructions manual



Wear protective equipment: hearing protection, eye protection, and helmet



Wear protection gloves



Wear protective footwear



Caution to exhaust gases



Do not smoke and do use the tool near naked flame



The accessible part are hot when operate the tool



Caution! Risk of rebound



Keep bystanders away at least 15mm



Warning – Risk of electric shock. Always beware of the danger from overhead electric-power line, keep a safe distance at least 10m from the power line



Caution! The tool can contact to a voluminous material. Loss of control and injuries can be created.



Warning – Risk of projection



Guarantee sound power level



Be careful of the cutting attachment!



The accessible surfaces are hot during operation



Do not use saw blades

2. YOUR PRODUCT

a. Description

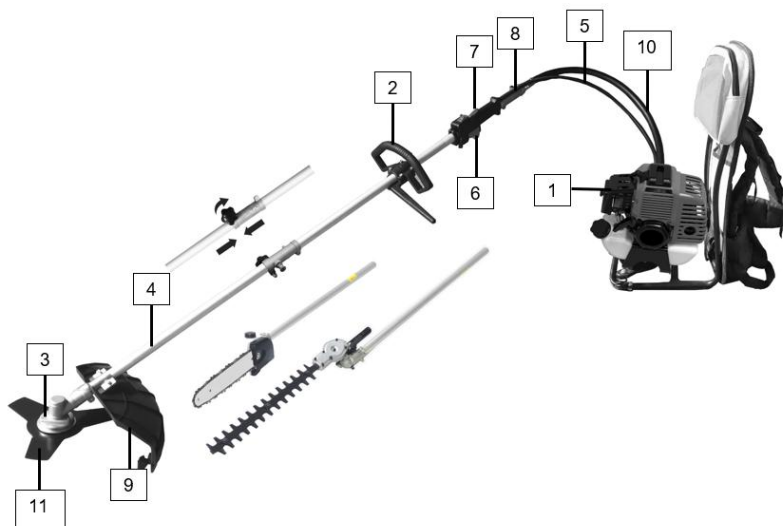

1. Unit
2. Handle
3. Cutting attachment installation
4. Tube
5. Command cord
6. Accelerator throttle
7. ON/OFF switch
8. Tube connector
9. Carter of protection
10. Flexible tube
11. Blade for brush cutter
12. Air filter
13. Choke lever
14. Starter rope
15. Fuel tank
16. Bag pack

Pruner

- 1- Tube
- 2- Lubrication oil tank
- 3- Saw



Hedge trimming

1. Tube
2. Adjustment lever
3. Notch adjustment at 135 ° of the cutting unit
4. Cutting blade

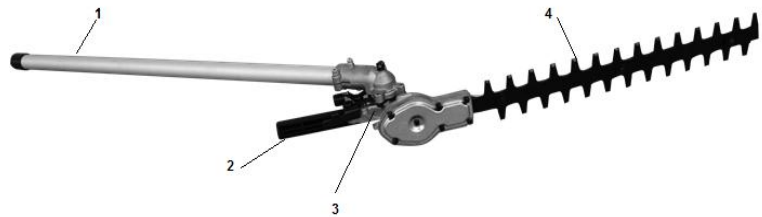

Brusher cutter

- 1- Protection cover
- 2- Blade

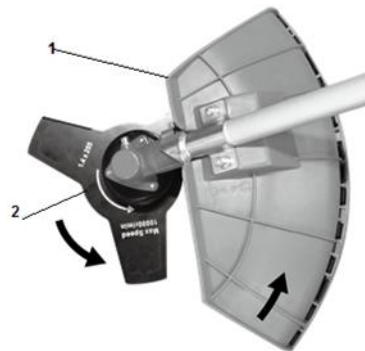

Trimmer

- 1- Nylon line
- 2- Device for cutting the nylon thread
- 3- Protection cover



b. Technical data

Machine mass	6.8kg
Volume of fuel tank	1200 cm ³
cutting attachments	Brushcutter: 255mmx1.4mm, 3 teethes,
	Grass trimmer: 2.5mmx420mm, flexible line
	Hedge trimmer: 390mm
	Pruner: 300mm, Oregon bar and chain guide
engine displacement	52 cm ³
Engine maximum speed	Grass trimmer: 9000 min ⁻¹ Brush cutter: 10000 min ⁻¹ Hedge trimmer: 10000 min ⁻¹ Pruner: 10000 min ⁻¹
maximum engine power	1,4 kW
maximum rotational frequency of the spindle	Grass trimmer: 6750 min ⁻¹ Brush cutter: 7500 min ⁻¹
engine idling speed range, in min⁻¹	3300±300 min ⁻¹
Volume of oil tank	140 cm ³
Sound power level	<u>Grass trimmer</u> Lwa = 113,2dB (A) K= 1,2 dB (A) <u>Brushcutter</u> Lwa = 112,1dB (A) K = 2,3 dB (A) <u>Pruner</u> Lwa : 112,7 dB (A) K=2,5 dB (A) <u>Hedge trimmer</u> Lwa : 110,9 dB (A) K=2,5 dB (A)

Sound pressure level	<u>Grass trimmer</u> LpA: 100 dB (A) K = 2,5 dB (A) <u>Brushcutter</u> LpA: 99,2 dB (A) K = 2,5 dB (A) Pruner LpA: 98 dB (A) K = 2,5 dB (A) <u>Hedge trimmer</u> LpA: 99 dB (A) K = 2,5 dB (A)
Vibration value	<u>Grass trimmer</u> 12 m/s ² K = 1.5m/s ² <u>Brushcutter</u> 9,5 m/s ² K = 1.5 m/s ² <u>Pruner</u> 2,2 m/s ² K = 1.5 m/s ² <u>Hedge trimmer</u> 2,4 m/s ² K = 1.5 m/s ²
Guaranteed sound power level	Grass trimmer: 114dB(A) Brushcutter: 114dB(A) Pruner: 115dB(A) Hedge trimmer: 113dB(A)
Model of the engine	RY1E44F-5

3. ASSEMBLY

Assembling the flexible tube with the engine and the pipe support

Pull the key which is on the clutch housing. Insert end of the flexible tube (with the hole) into the clutch housing on the engine until it locks in place. Release the key.

Insert the other end of the flexible tube into tube until it locks into place.
Make sure that the end of the flexible shaft is properly seated in the drive shaft seal.

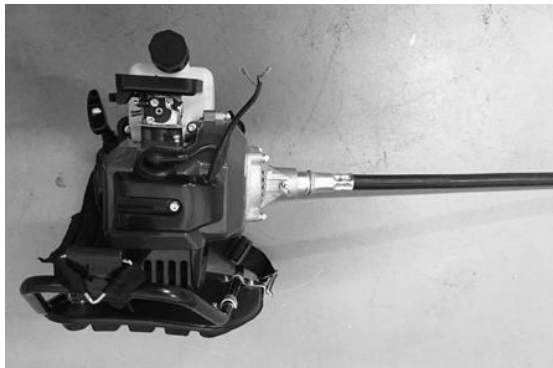

CAUTION: If the flexible tube is not inserted properly, the square end of the hose may not fit snugly in the drive shaft seal. Do not use force to avoid damage to the flexible shaft. Repeat the same procedure until the flexible shaft and hose are adjusted.

Connecting the command cord

- Connect the command cords to the two engine leads by inserting them into each other.



Mounting the throttle cable

- Remove the air filter cover.
- Place the throttle cable in the adjusting bolt. Be careful that the round hole of the rotating joint faces the end of the inner wire.
- Leave the rotating seal and make sure that the inside wire is properly seated in the hole.
- Reinstall the cover of the air filter.



Handle

Install the front handle as shown in the image. Do not fix the screws until you have set the most comfortable working position.

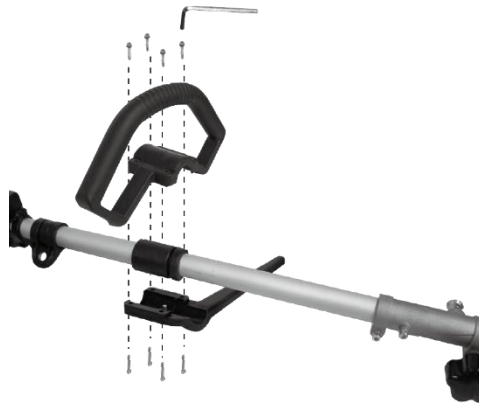

-Install the desired tube on the bar of the main unit. Make sure the locking pin is inserted into the hole in the bar.

-Fasten the bar by turning the nut counter clockwise.

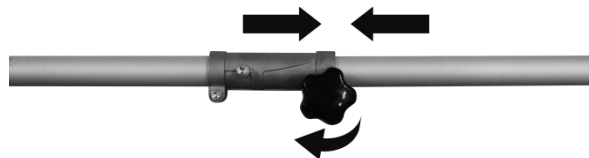

Carter of protection (brushcutter and grass trimmer)

- Remove the two screws from the guard.
- On the brushcutter / lawnmower tube, place the protective cover on its support.
- Screw the protective cover with the two screws.

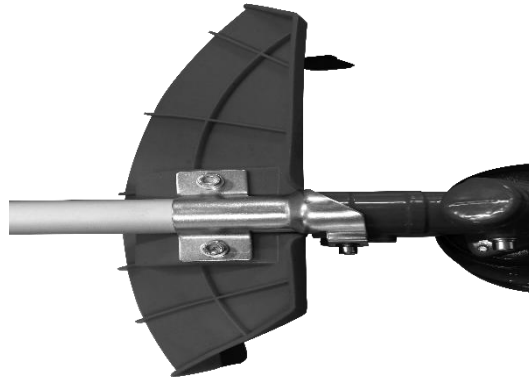

Installation of the 3-tooth metal blade (for operation of the brushcutter)

Warning - sharp edges; wear gloves when manipulate the blade.

- Insert a metal locking tool in the hole on the side of the drive sprocket and on the drive.
- Remove the retaining nut, the cover bell and the plate.
- Install in the following order, on the shaft: the blade, the plate, the cover bell and the retaining nut.
- Remove the metal locking tool.



Installing the nylon cutting head (for trimmer operation)

- Insert a metal locking tool in the hole on the side of the drive sprocket and on the drive shaft.
- Remove the retaining nut, the cover bell and the plate.
- Install and screw the nylon cutting head. Make sure it is properly installed.
- Remove the metal locking tool.

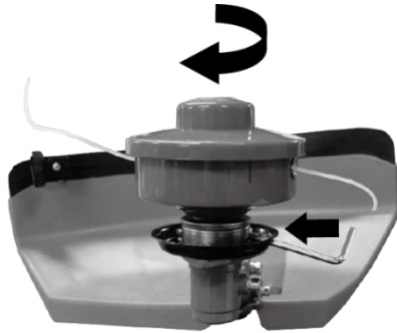

Hedge trimmer

- Install the bar of the main unit. Make sure the locking pin is inserted into the bar hole
- Fasten the bar by turning the nut counter clockwise.



1. Press the release / safety plate to loosen and turn the unit to the desired position depending on the nature of the work to be performed.
2. Loosen the release / safety plate ensuring that the cutting accessories are securely in place and secured.

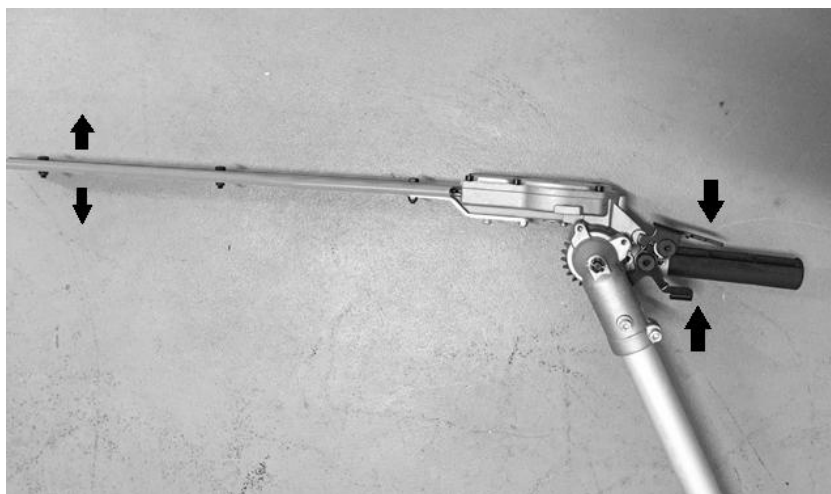

Pruner



-Tighten the tightening wheel

-Release the cutting blade to the machine tube (Make sure that the lock is engaged in the fixing hole.

-Set the wheel. Make sure the link is secure.

Assembly of the chain guide bar and chain saw

Remove the security screw and remove the protective cover



Position the chain guide so that the safety pin of the chain comes into the teeth of the chain. Make sure that the direction of movement of the cutting chain is correct. Install the chain guard and tighten the fixing screw

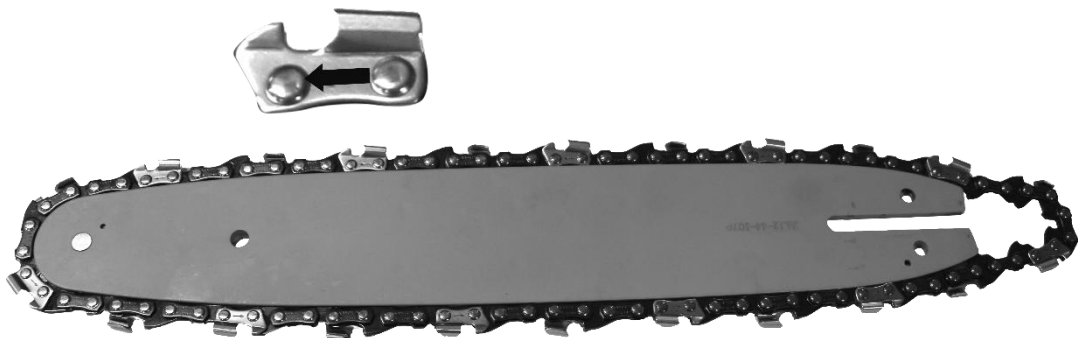

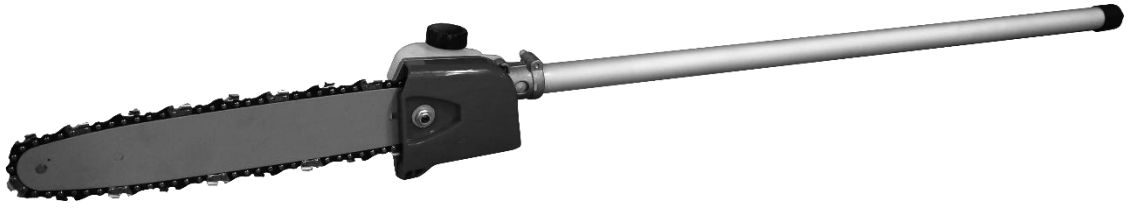

Adjusting the chain tension

The chain must not have too much clearance, but it must be possible to lift the chain a few millimetres from the guide rail.

- Loosen the fixing screw
- Raise the end of the chain guide slightly
- Check the ease of operation of the cutting chain by turning it manually.
- Adjust the tension of the chain (4) with the screw for adjusting the chain tension so that the chain can be lifted a few millimetres from the center of the guide rail.
- Fix the security screw.

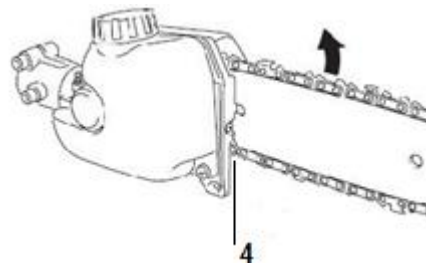

Installation of the harness

Hang the harness in its dedicated location on the tube. Adjust the size of the harness properly to have a correct working position.

The shoulder strap is equipped with an emergency release mechanism. To detach the machine from the shoulder strap in emergency situations, pull the rope to move away from the machine.



4. FUEL

Warning: Gasoline is highly flammable. Keep the fuel in specially designed cans.

Only fill the tank outside and do not smoke during the operation. Avoid sparks or open flames near the fuel.

Fill the tank before starting the engine. Never remove the fuel tank cap, add fuel while the engine is still running, or while the engine is still warm.

Avoid overfilling the tank: When excess fuel has escaped, do not attempt to start the engine, but move the machine away and avoid any sources of ignition in the vicinity until the fuel vapors have dissipated.

Fully tighten all fuel filler caps and cans.

Fill the tank on the floor.

The engine must be started at a distance of at least 3 meters from where the fuel tank has been filled.

Switch off the engine before adding fuel. Shake the mixture thoroughly before filling the tank.

Store gasoline in tanks specially designed for this purpose.

Fill the fuel tank of your appliance outdoors and avoid smoking during work.

Fill the tank before starting the engine. Never open the fuel tank cap or fill fuel tank while the engine is running or the engine is still hot.

Avoid spilling gasoline: When gasoline is spilled, do not start the machine and move it away from where the gasoline has spilled to avoid possible sources of fire.

Screw all caps and tank cover carefully.

This type of tool is designed to be used with unleaded gasoline. Using unleaded gasoline prevents unnecessary pollution in the interests of your health and the protection of the environment. Using gasoline or oil of lesser quality can damage seal rings, ducts or fuel tank. Exhaust emissions are regulated by the basic technical characteristics of the engine and its components (carburation, adjustment of spark plugs, control of exhaust opening and closing times) in the absence of accessories or a catalyst during combustion.

Mix

- Use the supplied bottle to mix.
- Put the oil and then the fuel. Mix thoroughly for at least one minute Fuel ratio (petrol: 2 stroke engine: oil 40: 1)

Filling the tank

- Unscrew the tank cap.
- Fill the tank to 80% of its capacity.
- Screw the fuel cap back on. Clean the fuel tank cap and the area around after filling the fuel tank. Eliminate overfill of fuel mixture by rubbing.

5. OPERATION

Cold starting

- Put the tool on a plane surface.
- Push the ON/OFF switch on the ON position.



- Close the choke lever.

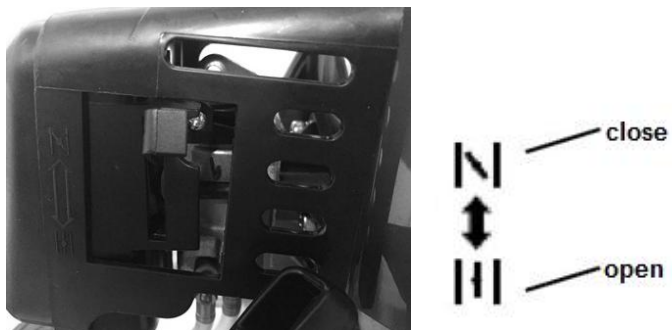

- Push the priming bulb 7 to 10 times. **Pull the starter rope several times when the engine boom.**

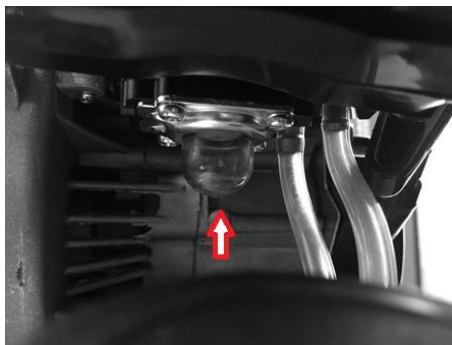

- **Open the choke lever. Pull the starter rope until the engine starts.**

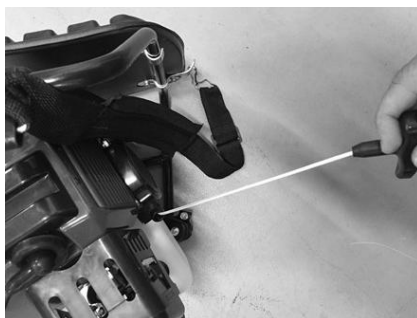

- Press and hold the safety switch and then accelerator throttle to start the operation

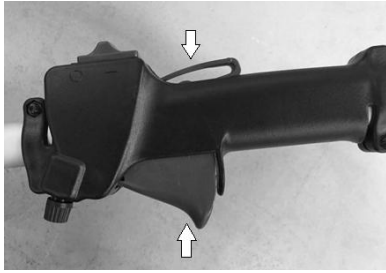

Hot starting

- Partial the choke lever or open the choke lever

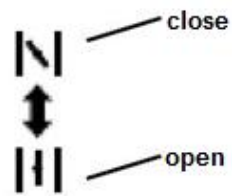

- Pull the starter rope.

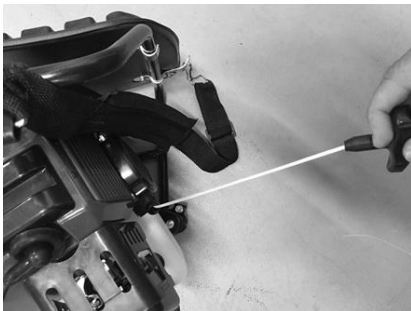

- Press and hold the safety switch and then accelerator throttle to start the operation

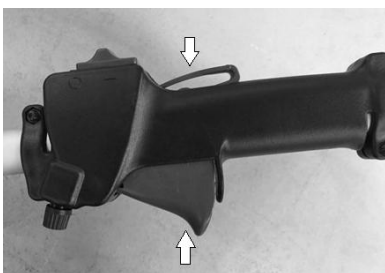

Stopping

- Release the accelerator throttle.
- Push the ON/OFF switch on the OFF position.



- Let the tool completely stop

a) Grass trimmer operation

- Trimming

Tilt the head slowly to direct debris away from you. If cutting up to a barrier such as fence, wall or tree, approach from an angle where any debris ricocheting off the barrier will fly away from you. Move the line head slowly until the grass is cut right up to the barrier, but do not jam (overfeed) the line into the barrier. If trimming up to a wire mesh or chain linked fence be careful to feed only up to wire. If you go too far the line will snap off around the wire. Trimming can be done to cut through weed stems one at a time. Place the trimmer line head near the bottom of the weed-never high up which could cause the weed to chatter and catch the line. Rather than cut the weed right through, just use the very end of the line to wear through the stem slowly.

- Scalping and edging

Both of these are done with the line head tilted at a steep angle. Scalping is removing top growth leaving the earth bare.

Edging is trimming the grass back where it has spread over a sidewalk or drive way. During both edging and scalping, hold the unit a steep angle and in a position where the debris, and any dislodging dirt and stones, will not come back towards you even if it ricochets off the hard surface. Although the picture shows how to edge and scalp every operator must find for himself the angles which suits his body size and cutting situation.

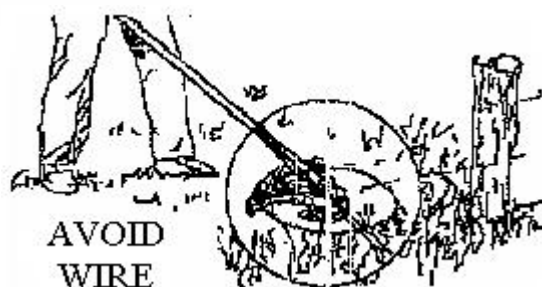
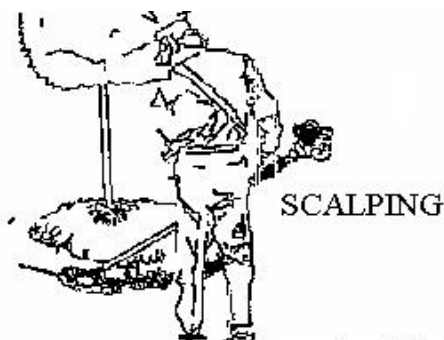

b) **Brushcutter operation**

- Do not use the brushcutter for cutting trees
- Do not cut with dull, cracked or damaged metal blade.
- Before cutting growth, inspect for obstructions such as boulders, metal stakes or strands of wire from broken fences. If an obstruction cannot be removed, mark its location so that you can avoid it with the blade. Rocks and metal will dull or damage a blade. Wire can catch on the blade head and flap around or be thrown into the air.
- Use the shoulder harness at all times adjust both harness and harness clamp on the unit so that the unit hangs a few inches above ground level. The cutting head and the debris shield should be level in all directions. Harness the unit on the right side of your body.
- Cut only with the side of the blade that the debris is moving away from you.
- If kickback occurs, the blade may be dull, or the material so thick and hard that you should use other tool instead of this machine.
- Do not force the blade to cut. Do not change the angle of cut after into the wood. Avoid using any pressure or leverage which could cause the blade to bind or crack.

Scything weeds

This is cutting by swinging the blade in a level arc. It can quickly clear areas of field grass and weeds. Scything should not be used to cut large, tough weeds or woody growths.

Scything can be done in both directions, or just in one way which results in the debris being thrown away from you.

That is using the side of the blade that it is rotating away from you. Tilt down the blade slightly on this same side. You will be hit by some debris if you scythe in both directions.

6. MAINTENANCE AND STORAGE

After each use, bring cleaning and maintenance to the tool; check for loose fasteners, fuel leaks and damaged parts, such as cracks in the cutting attachments. Keep the machine in good working condition.

a) **Air filter**

- Accumulated dust in the air filter will reduce engine efficiency. Increase fuel consumption and allow abrasive particles to pass into the engine. Remove the air filter as often as necessary to maintain in a clean condition. Light surface dust can readily be removed by tapping the filter. Heavy deposits should be washed out in suitable solvent.
- Remove filter cover by loosening air filter cover knob.

b) Adjusting the carburettor and ignition

Do not adjust carburettor and ignition unless necessary. If you have trouble with the carburettor and the ignition, bring the tool to a service agent for inspection. Improper adjustment may cause engine damage and void warranty.

c) Fuel filter

When the inside of the fuel tank is dirty, it can be cleaned by rinsing the tank out with gasoline.

d) Spark plug

Do not attempt to remove the plug from a hot engine in order to avoid possible damage to the threads.

- Clean or replace the spark plug in case of ozone contamination.
- Replace the spark plug if the end of the center electrode is worn.

e) Sharpening of the blade of the pruner

Check each time the condition of the saw blade. When the teeth of the saw blade need to be sharpened, it shall be done by a service agent.

f) Handling and transport

- The engine should be turned off when the unit is moved between work areas.
- After the engine has stopped, the muffler is still hot. Never touch hot parts such as the muffler.
- Confirm that the fuel is not leaked from tank.
- Transport the tool in a way to prevent loss of fuel, injuries and damage.
- Dismantle the cutting head and the blade before transport and storage. Put the blade in its packing.

g) Storage

- Inspect, clean and have the appliance repaired if necessary
- Empty the tank.
- Switch on the appliance to consume all remaining fuel.
- Remove the spark plug and pour a teaspoon of clean engine oil into the cylinder cavity of the spark plug, replace the spark plug
- Store cutting elements so that they cannot be touched (wrap them, for example.)
- Store in a clean, dry, dust-free area.

7. CE DECLARATION



BUILDER SAS

ZI, 32, rue Aristide Bergès – 31270 Cugnaux - France

Tel: +33 (0)5.34.502.502 Fax: +33 (0)5.34.502.503

Declares that the machine:

GASOLINE MULTI TOOL KIT 52CC

HCOMBIBP50

Serial No: 20201236612-20201237350

Have been designed in compliance with the following standards:

EN ISO 11680-1:2011

EN ISO 11680-2:2011

EN ISO 11806-1:2011

EN ISO 11806-2:2011

EN ISO 10517-1:2019

EN ISO 14982: 2009

And in accordance with the following directives:

Directive Machine 2006/42/EC

Directive EMC 2014/30/EU

Emission directive (EU) 2016/1628

Noise Directive 2000/14/EC Annex V & Directive 2005/88/EC

Sound power level	<u>Grass trimmer</u>
	Lwa = 113,2dB (A)
	K= 1,2 dB (A)
	<u>Brushcutter</u>

	<p>Lwa = 112,1dB (A)</p> <p>K = 2,3 dB (A)</p> <p><u>Pruner</u></p> <p>Lwa : 112,7 dB (A)</p> <p>K=2,5 dB (A)</p> <p><u>Hedge trimmer</u></p> <p>Lwa : 110,9 dB (A)</p> <p>K=2,5 dB (A)</p>
Guaranteed sound power level	<p>Grass trimmer: 114dB(A)</p> <p>Brushcutter: 114dB(A)</p> <p>Pruner: 115dB(A)</p> <p>Hedge trimmer: 113dB(A)</p>

Responsible of the Technical file: M. Olivier Patriarca

Philippe MARIE / PDG



Cugnaux, 01/01/2021

8. WARRANTY

HYUNDAI

WARRANTY

The manufacturer guarantees the product against defects in material and workmanship for a period of 2 years from the date of the original purchase. The warranty only applies if the product is for household use. The warranty does not cover breakdowns due to normal wear and tear.

The manufacturer agrees to replace parts identified as defective by the designated distributor. The manufacturer does not accept responsibility for the replacement of the machine, in whole or in part, and/or ensuing damage.

The warranty does not cover breakdowns due to:

- insufficient maintenance.
- abnormal assembly, adjustment or operations of the product.
- parts subject to normal wear and tear.

The warranty does not extend to:

- shipping and packaging costs.
- using the tool for a purpose other than that for which it was designed.
- the use and maintenance of the machine done in a manner not described in the user manual.

Due to our policy of continuous product improvement, we reserve the right to alter or change specifications without notice. Consequently, the product may be different from the information contained therein, but a modification will be undertaken without notice if it is recognized as an improvement of the preceding characteristic.

READ THE MANUAL CAREFULLY BEFORE USING THE MACHINE.

When ordering spare parts, please indicate the part number or code, you can find this in the spare parts list in this manual. Keep the purchase receipt; without it, the warranty is invalid. To help you with your product, we invite you to contact us by phone or via our website:

- **+33 (0)9.70.75.30.30**
- **<https://services.swap-europe.com/contact>**

You must create a "ticket" via the web platform.

- Register or create your account.
- Indicate the reference of the tool.
- Choose the subject of your request.
- Describe your problem.
- Attach these files: invoice or sales receipt, photo of the identification plate (serial number), photo of the part you need (for example: pins on the transformer plug which are broken).



9. PRODUCT FAILURE

WHAT TO DO IF MY MACHINE BREAKS DOWN?

If you bought your product in a store:

- a) Empty the fuel tank.
- b) Make sure that your machine is complete with all accessories supplied, and clean! If this is not the case, the repairer will refuse the machine.

Go to the store with the complete machine and with the receipt or invoice.

If you bought your product on a website:

- a) Empty the fuel tank.
- b) Make sure that your machine is complete with all accessories supplied, and clean! If this is not the case, the repairer will refuse the machine.
- c) Create a SWAP-Europe service ticket on the site: <https://services.swap-europe.com> When making the request on SWAP-Europe, you must attach the invoice and the photo of the nameplate (serial number).
- d) Contact the repair station to make sure it is available before dropping off the machine.

Go to the repair station with the complete machine packed, accompanied by the purchase invoice and the station support sheet downloadable after the service request is completed on the SWAP-Europe site

For machines with engine failure from manufacturers BRIGGS & STRATTON, HONDA and RATO, please refer to the following instructions.

Repairs will be done by approved engine manufacturers of these manufacturers, see their site:

- <http://www.briggsandstratton.com/eu/fr>
- <http://www.honda-engines-eu.com/fr/service-network-page;jsessionid=5EE8456CF39CD572AA2AEEDFD290CDAE>
- <https://www.rato-europe.com/it/service-network>

Please keep your original packaging to allow for after-sales service returns or pack your machine with a similar cardboard box of the same dimensions.

For any question concerning our after-sales service you can make a request on our website <https://services.swap-europe.com>

Our hotline remains available at +33 (9) 70 75 30 30.



10. WARRANTY EXCLUSIONS

THE WARRANTY DOES NOT COVER:

- Start-up and setting up of the product.
- Damage resulting from normal wear and tear of the product.
- Damage resulting from improper use of the product.
- Damage resulting from assembly or start-up not in accordance with the user manual.
- Breakdowns related to carburetion beyond 90 days and fouling of carburetors.
- Periodic and standard maintenance events.
- Actions of modification and dismantling that directly void the warranty.
- Products whose original authentication marking (brand, serial number) has been degraded, altered or withdrawn.
- Replacement of consumables.
- The use of non-original parts.
- Breakage of parts following impacts or projections.
- Accessories breakdowns.
- Defects and their consequences linked to any external cause.
- Loss of components and loss due to insufficient screwing.
- Cutting components and any damage related to the loosening of parts.
- Overload or overheating.
- Poor power supply quality: faulty voltage, voltage error, etc.
- Damages resulting from the deprivation of enjoyment of the product during the time necessary for repairs and more generally the costs related to the immobilization of the product.
- The costs of a second opinion established by a third party following an estimate by a SWAP-Europe repair station
- The use of a product which would show a defect or a breakage which was not the subject of an immediate report and/or repair with the services of SWAP-Europe.
- Deterioration linked to transport and storage*.
- Launchers beyond 90 days.
- Oil, petrol, grease.
- Damages related to the use of non-compliant fuels or lubricants.

* In accordance with transport legislation, damage related to transport must be declared to carriers within 48 hours maximum after observation by registered letter with acknowledgement of receipt.

This document is a supplement to your notice, a non-exhaustive list.

Attention: all orders must be checked in the presence of the delivery person. In case of refusal by the delivery person, it you must simply refuse the delivery and notify your refusal.

Reminder: the reserves do not exclude the notification by registered letter with acknowledgement within 72 hours.

Information:

Thermal devices must be wintered each season (service available on the SWAP-Europe site). Batteries must be charged before being stored.

HYUNDAI
POWER PRODUCTS

For Inquiries, please contact:

BUILDER SAS

32, rue Aristide Bergès Z1 31270 Cugnaux, France

Tél. : +33 (0) 5.34.502.502 Fax : +33 (0) 5.34.502.503

<http://www.hyundai-power-fr.com/>

Fabriqué en République Populaire de Chine (PRC)